

Digital Pyroelectric infrared Motion Sensor Module

SL116

Introduction:

SL116 Digital Pyroelectric infrared motion sensor module is an autocontrol product based on infrared ray integrated technology, with high sensitivity, reliability, ULV working pattern and small size. This module can be widely used in multiple auto-induction electric equipment, especially autocontrol products whose power are supplied by dry battery.

Feature:

- Automatic induction: When human comes into the detecting range, module will output high level. When human comes out of the rang, module will output low level instead of high level.
- Photosensitivity controlling (optional) : Set photosensitivity to control the switch, no detection while in daytime or strong light.
- Inner-setting processing chip: Internally set an analog-digital processing integrate as inner-setting processing chip, combining with the sensor. It blocks the RFI of the shell in order to stabilize the product.
- Inner-setting analog-digital chip: The product converts the analog signal transmitted by sensitivity unit into digital signal by 16 bit high-accuracy AD converter. With the addition of dedicated filter, it effectively filter various low and high frequency noise interference.
- Triggering mode: When the infrared signal received by sensor exceeds the internal threshold, it will launch a counter pulse. A second signal will be considered as a second pulse by the sensor. Once a second pulse is received within 4 seconds, the sensor will output high level. Moreover, as long as the amplitude of the signal exceeds 5 times of the trigger threshold value, only one pulse is needed to output high level. If the sensor continuously receives triggering signal, the hold time of high level will start from the last effective triggering till the end.
- Sensing blocking time(default setting: blocking time 2.5s): After the sensing output of the sensing module(high level turns into low level), there could be a blocking time. During this period, the sensor reject any sensing signal. It is a function that the working interval between sensing output time and blocking time can be applied interval detection products. Meanwhile, this function can effectively restrain the interference caused by load switchover.
- Wide operating voltage range: DC2.7V-18V。
- Micro power consumption: When DC3V and quiescent current ≤ 20 uA, the module is particularly suitable for battery-powered autocontrol products
- Output high level signal: The module can easily dock with many kinds of circuit.
- Long detection distance: Up to 8 meters

Application:

- PIR motion sensor lamp
- PIR motion toy
- Security product
- Industrial autocontrol
- Auto sensing electrical equipment
- Battery-powered autocontrol

Technical parameters:

Operating Voltage Range	DC2.7-18V
Quiescent Current	≤20uA while 3V
Level Output	High 3.3 V / low 0V
Triggering Mode	Default repeatedly triggering
Delay Time	Default 5S (2.3-4793s adjustable)
Blocking Time	Default 2.5S
Circuit Board Dimension	Φ16*1.2MM
Detection Angle	<120° taper angle (Depends on performance of the lens)
Detection Range	Up to 8 meters (Depends on performance of the lens)
Operating Temperature	-20° -+50°
Lens Dimension	Φ12.45 High 10.78

Physical Dimension:

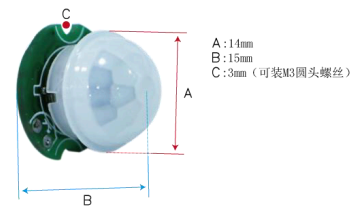
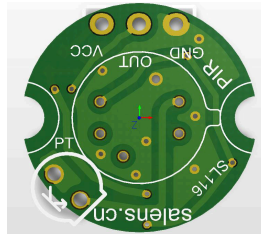
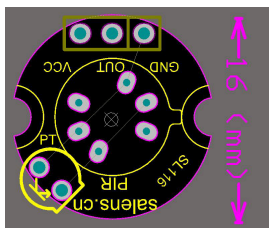

Figures

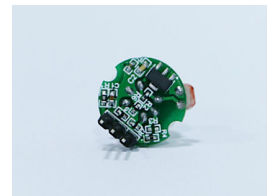

Detection Range:

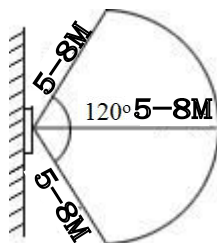

Wall mount

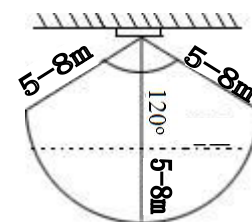

Ceiling mount

Schematic Diagram:

Module external schematic diagram		1.Anode 2.OUT signal 3.Cathod
Dc load circuit diagram		
Ac load circuit diagram		

Time Delay Regulation

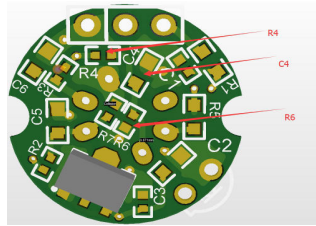
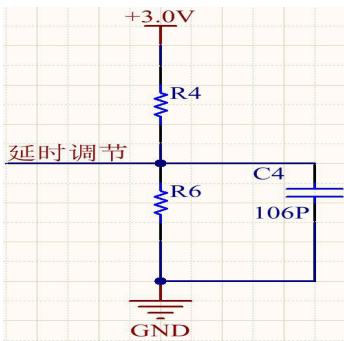

电压	On-Time 计数	On-Time 配对电阻推荐	On-Time (3.3V) 参考电压	典型时间
VDD*3/128~0	0	NC	0R	<4秒
VDD*3/128	1	1M	24k	>0.077
VDD*5/128	2	1M	39k	>0.129
VDD*7/128	3	1M	56k	>0.180
VDD*9/128	4	1M	75k	>0.232
VDD*11/128	5	1M	91k	>0.284
VDD*13/128	6	1M	110k	>0.335
VDD*15/128	7	1M	130k	>0.387
VDD*17/128	8	1M	150k	0.438
VDD*19/128	9	1M	174k	>0.490
VDD*21/128	10	1M	200k	>0.541
VDD*23/128	11	1M	220k	>0.593
VDD*25/128	12	1M	240k	>0.645
VDD*27/128	13	1M	270k	>0.696
VDD*29/128	14	1M	294k	>0.748
VDD*31/128	or	0R	NC	>0.8
				1小时 20分钟

Time delay regulation range: 0V to $\frac{1}{4}V_{DD}$

Sensitivity Control

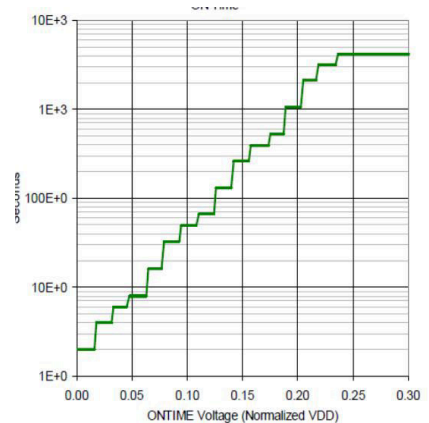
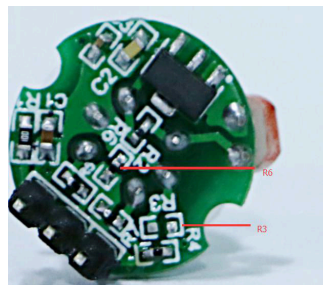
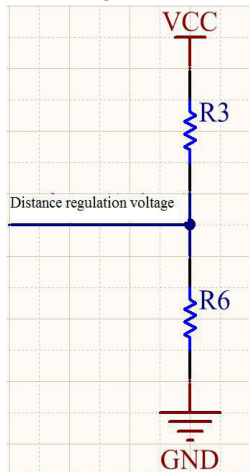

The detection range goes to the longest while taking out R2 and C5, R7 connects 0Ω. Sensitivity control range: 0V to $\frac{1}{4}V_{DD}$

Notification:

- There is a 10-sec initialization time after power on. During the period, the module will alternately output 0 to 3 times and enter normal standby status 30 seconds later.
- Please try to avoid the light and other interference source to directly irradiate the lens on the module while setting. Try to avoid floating wind which will affect the sensor as well.
- Notice the angle during setup to avoid the effect on detection distance. Set the square window of the module in parallel with the direction of human body activity to reach the best performance.
- The detection range will decrease if the environment temperature rises to 30°C-32°C.